



Dell UltraSharp UP3017Q User's Guide

Model: UP3017Q
Regulatory model: UP3017Qt



 **NOTE:** A NOTE indicates important information that helps you make better use of your computer.

 **CAUTION:** A CAUTION indicates potential damage to hardware or loss of data if instructions are not followed.

 **WARNING:** A WARNING indicates a potential for property damage, personal injury, or death.

Copyright © 2016 Dell Inc. All rights reserved. This product is protected by U.S. and international copyright and intellectual property laws.

Dell™ and the Dell logo are trademarks of Dell Inc. in the United States and/or other jurisdictions. All other marks and names mentioned herein may be trademarks of their respective companies.

Contents

| | |
|--|-----------|
| About Your Monitor | 5 |
| Package Contents | 5 |
| Product Features | 7 |
| Identifying Parts and Controls | 8 |
| Monitor Specifications | 10 |
| Plug-and-Play | 18 |
| OLED Monitor Quality and Pixel Policy | 18 |
| Setting Up the Monitor | 19 |
| Attaching the Stand | 19 |
| Using the Tilt, Swivel and Vertical Extension | 22 |
| Adjusting the Rotation Display Settings of Your System | 22 |
| Connecting Your Monitor | 23 |
| Organizing Your Cables | 25 |
| Removing the Monitor Stand | 26 |
| Wall Mounting (Optional) | 27 |
| OLED Screen Protection Mode | 28 |
| Operating the Monitor | 29 |
| Turning on the Monitor | 29 |
| Using the Front Panel Controls | 29 |
| Using the On-Screen Display (OSD) Menu | 32 |





| | |
|--|-----------|
| Troubleshooting | 45 |
| Self-Test | 45 |
| Built-in Diagnostics | 47 |
| Common Problems | 48 |
| Product Specific Problems | 49 |
| Appendix | 51 |
| Safety Instructions | 51 |
| FCC Notices (U.S. only) and Other Regulatory Information | 51 |
| Contacting Dell | 51 |
| Setting Up Your Monitor | 52 |
| Maintenance Guidelines | 54 |

About Your Monitor

Package Contents

Your monitor ships with the components shown below. Make sure that you have received all the components and [contact Dell](#) if something is missing.

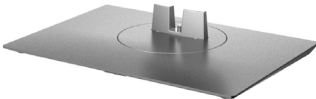
 **NOTE:** Some items may be optional and may not ship with your monitor. Some features or media may not be available in certain countries.

| | |
|---|---------------------------------|
|  | Monitor |
|  | Stand riser |
|  | Stand base |
|  | Power cable (varies by country) |

| | |
|--|---|
|  | <p>Power adapter</p> |
|  | <p>HDMI cable</p> |
|  | <p>DP cable (mDP to DP)</p> |
|  | <p>mDP cable (mDP to mDP)</p> |
|  | <p>USB Type C cable (C to C)</p> |
|  | <p>USB Type C cable (C to A)</p> |
|  | <p>USB Type C Holder</p> |
|  | <p>Cleaning cloth</p> |
|  | <ul style="list-style-type: none"> • Drivers and documentation media • Quick Setup Guide • Safety and Regulatory Information • Factory Calibration Report |

Product Features

The **Dell UltraSharp UP3017Q** monitor has an Active Matrix Organic Light Emitting Diode (AMOLED) that uses LTPS TFT(Low Temperature Poly Silicon Thin Film Transistor) as switching components. The monitor features include:

- 76.19 cm (30.0-inch) viewable area display (measured diagonally).
- Wide color coverage of 100% AdobeRGB, sRGB & Rec709, 97.5% DCI-P3 and 85.8% Rec2020, 114.8% NTSC (CIE1931), 126.5% NTSC (CIE1976).
- 14-bit Gamma LUT.
- Wide viewing angle to allow viewing from a sitting or standing position, or while moving from side-to-side.
- Supports HDMI, USB Type-C, Mini DisplayPort sources.
- Tilt, swivel and vertical extension adjustment capabilities.
- Removable pedestal and Video Electronics Standards Association (VESA™) 100 mm mounting holes for flexible mounting solutions.
- Single USB Type-C to supply power to compatible notebook while receiving video signal.
- On-Screen Display (OSD) adjustments for easy set-up and screen optimization.
- Software and documentation media includes an information file (INF), Image color Matching File (ICM), Dell Display Manager software application and product documentation. Dell Display Manager included (comes in the USB thumb driver).
- Security lock slot.
- Asset Management Capability.
- RoHS compliant.
- BFR/PVC Free monitor (excluding cables).
- Arsenic-Free glass and Mercury Free.
- Energy Gauge shows the energy level being consumed by the monitor in real time.
- TCO Certified Displays.
- Dedicated Custom Color Mode (6-axis Color-control) for Saturation, Hue, Gain (RGB) and offset (RGB).

Identifying Parts and Controls

Front view

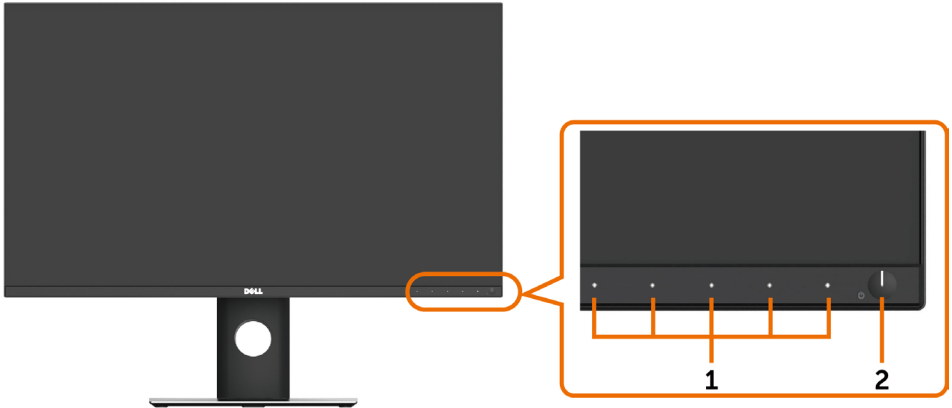

| Label | Description |
|-------|---|
| 1 | Function buttons (For more information, see Operating the Monitor) |
| 2 | Power on/off button (with LED indicator) |

Back View



| Label | Description | Use |
|-------|--|--|
| 1 | VESA mounting holes (100 mm x 100 mm-behind attached VESA cover) | Wall mount monitor using VESA-compatible wall mount kit (100 mm x 100 mm). |
| 2 | Regulatory label | Lists the regulatory approvals. |
| 3 | Stand release button | Release stand from monitor. |
| 4 | Security lock slot | Secures monitor with security cable lock (sold separately). |

| | | |
|---|---|--|
| 5 | Barcode, serial number, and Service Tag label | Refer to this label if you need to contact Dell for technical support. |
| 6 | Cable management slot | Use to organize cables by placing them through the slot. |

Bottom View

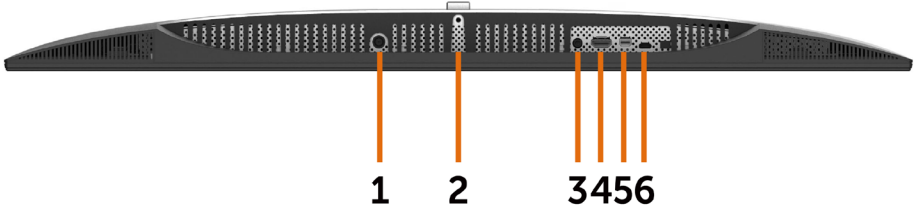

| Label | Description | Use |
|-------|----------------------|---|
| 1 | DC power connector | To connect the monitor power cable. |
| 2 | Stand lock feature | To lock the stand to the monitor using a M3 x 6mm screw (screw not included). |
| 3 | Audio line-out port | Connect speakers to playback audio coming through HDMI or DP audio channels. Only supports 2-channel audio. NOTE: The audio line-out port does not support headphones. ⚠ WARNING: Excessive sound pressure from earphones or headphones can cause hearing damage or loss. |
| 4 | HDMI connector | Connect your computer with HDMI cable. |
| 5 | mDP connector | Connect your computer with mDP to DP or mDP to mDP cable. |
| 6 | USB Type C connector | Connect your computer with USB Type C cable. |

Monitor Specifications

| | |
|------------------------|--|
| Panel type | OLED |
| Viewable image | |
| Diagonal | 76.19 cm (30 inches) |
| Active Area | |
| Horizontal | 699.86 mm (27.55 inches) |
| Vertical | 379.22 mm (14.93 inches) |
| Area | 265400.90 mm ² (411.32 inches ²) |
| Aspect Ratio | 16:9 |
| Pixel pitch | 0.173 mm x 0.173 mm |
| Pixel Per Inch (PPI) | 147 |
| Viewing angle | |
| Horizontal | 178° (typical) |
| Vertical | 178° (typical) |
| Brightness | Typ. 300 cd/m ² (≤1% Load), Typ. 120 cd/m ² (100% Load) Note: Loading is proportional to screen content. A full white page is 100% loading. Note: Luminance output when Uniformity Compensation is OFF. |
| Mini Luminance (Black) | 0.0005 cd/m ² Note: Limited by equipment tolerance (min measurable 0.0005 cd/m ²) |
| Contrast ratio | 1000,000:1 (Perceptual) 600,000:1 (≤1% Load) 200,000:1 (100% Load) Note: Measurable contrast ratio is limited by equipment tolerance. Perceptual contrast ratio is derived assuming optical equipment can measure to below 0.0005 cd/m ² . |
| Display Screen Coating | AR (Anti-Reflection) reflectivity: 4.5% Hardness 2H |
| Response time | 90us (on/off) |
| Color depth | 1.07 Billion colors (10bits) |
| Color gamut | 100% AdobeRGB 100% sRGB 100% Rec709 97.5% DCI-P3 85.8% Rec2020 114.8% NTSC (CIE1931) 126.5% NTSC (CIE1976) |

| | |
|--------------|---|
| Connectivity | mDP (1.2) HDMI (2.0) USB Type C (Alternate mode with DP1.2, Power Delivery PD up to 100W) |
|--------------|---|

Resolution Specifications

| | |
|--|--|
| Horizontal scan range | 30 kHz to 133 kHz |
| Vertical scan range | 30 Hz to 60 Hz |
| Screen refresh rate | 60Hz, 120Hz (selectable) 96Hz (for 24Hz input only) |
| Maximum preset resolution | 3840 x 2160 at 60 Hz |
| Video display capabilities (DP & HDMI playback) | 480p, 576p, 720p, 1080p |

Preset Display Modes

| Display Mode | Horizontal Frequency (kHz) | Vertical Frequency (Hz) | Pixel Clock (MHz) | Sync Polarity (Horizontal/Vertical) |
|--------------|----------------------------|-------------------------|-------------------|-------------------------------------|
| 720 x 400 | 31.5 | 70.0 | 28.3 | -/+ |
| 640 x 480 | 31.5 | 60.0 | 25.2 | -/- |
| 640 x 480 | 37.5 | 75.0 | 31.5 | -/- |
| 800 x 600 | 37.9 | 60.0 | 40.0 | +/+ |
| 800 x 600 | 46.9 | 75.0 | 49.5 | +/+ |
| 1024 x 768 | 48.4 | 60.0 | 65.0 | -/- |
| 1024 x 768 | 60.0 | 75.0 | 78.8 | +/+ |
| 1152 x 864 | 67.5 | 75.0 | 108.0 | +/+ |
| 1280 x 800 | 49.3 | 60.0 | 71.0 | +/+ |
| 1280 x 1024 | 64.0 | 60.0 | 108.0 | +/+ |
| 1280 x 1024 | 80.0 | 75.0 | 135.0 | +/+ |
| 1600 x 1200 | 75.0 | 60.0 | 162.0 | -/+ |
| 1920 x 1080 | 67.5 | 60.0 | 193.5 | +/+ |
| 2048 x 1152 | 71.6 | 60.0 | 197.0 | +/- |
| 2560 x 1440 | 88.8 | 60.0 | 241.5 | +/- |
| 3840 x 2160 | 65.68 | 30.0 | 262.75 | +/+ |
| 3840 x 2160 | 133.313 | 60.0 | 533.25 | +/+ |

Electrical Specifications

| | |
|--------------------------------------|---|
| Video input signals | <ul style="list-style-type: none">• Digital video signal for each differential line Per differential line at 100 ohm impedance• HDMI/mDP/USB Type C signal input support |
| AC/DC adapter: | |
| Input voltage/ frequency/ current | 100-240V AC / 50 or 60 Hz \pm 3 Hz / 3A (maximum) |
| Output voltage/current | Output: 19.5V DC / 12.3 A |
| Inrush current | 120 V: 40 A (Max.) 240 V: 80 A (Max.) |

Physical Characteristics

| | |
|----------------------------|--|
| Connector type | <ul style="list-style-type: none">• Audio line-out• HDMI connector• mDP connector• USB Type C connector |
| Signal cable type | HDMI 1.8 M cable mDP to DP 1.8 M cable mDP to mDP 1.8 M cable USB Type C to Type C 1.8 M cable USB Type C to Type A 1.8 M cable |
| Dimensions (with stand) | |
| Height (extended) | 556.3 mm (21.90 inches) |
| Height (compressed) | 456.3 mm (17.96 inches) |
| Width | 686.2 mm (27.02 inches) |
| Depth | 191.6 mm (7.54 inches) |
| Dimensions (without stand) | |
| Height | 405.4 mm (15.96 inches) |
| Width | 686.2 mm (27.02 inches) |
| Depth | 44.7 mm (1.76 inches) |
| Stand dimensions | |
| Height (extended) | 427.5 mm (16.83 inches) |
| Height (compressed) | 395.5 mm (15.57 inches) |
| Width | 286.6 mm (11.28 inches) |
| Depth | 191.6 mm (7.54 inches) |
| Weight | |
| Weight with packaging | 20.20 kg (44.53 lb) |

| | |
|---|---------------------|
| Weight with stand assembly and cables | 10.14 kg (22.35 lb) |
| Weight without stand assembly (For wall mount or VESA mount considerations - no cables) | 6.43 kg (14.17 lb) |
| Weight of stand assembly | 2.41 kg (5.31 lb) |

Environmental Characteristics

| | |
|---------------------|--|
| Temperature | |
| Operating | 0°C to 35°C (32°F to 95°F) |
| Non-operating | -20°C to 60°C (-4°F to 140°F) |
| Humidity | |
| Operating | 10% to 80% (non-condensing) |
| Non-operating | 5% to 90% (non-condensing) |
| Altitude | |
| Operating | 5,000 m (16,404 ft) (maximum) |
| Non-operating | 12,192 m (40,000 ft) (maximum) |
| Thermal dissipation | 820 BTU/hour (maximum) 360 BTU/hour (typical) |

Power Management Modes

If you have VESA's DPM-compliant video card or software installed in your PC, the monitor can automatically reduce its power consumption when not in use. This is referred to as power save mode*. If the computer detects input from the keyboard, mouse, or other input devices, the monitor automatically resumes functioning. The following table shows the power consumption and signaling of this automatic power saving feature.

| VESA Modes | Horizontal Sync | Vertical Sync | Video | Power Indicator | Power Consumption |
|------------------|-----------------|---------------|--------|----------------------------|--------------------------------------|
| Normal operation | Active | Active | Active | White | 240 W (maximum)** 105 W (typical) |
| Active-off mode | Inactive | Inactive | Off | White (blinking slowly) | Less than 0.5 W |
| Switch off | - | - | - | Off | Less than 0.3 W |

The OSD operates only in the normal operation mode. If you press any button in the active-off mode, one of the following message is displayed:

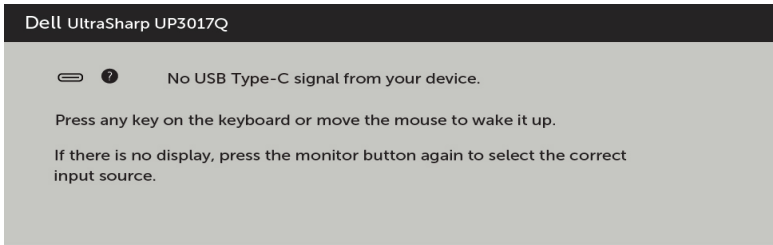

*Zero power consumption in OFF mode can only be achieved by disconnecting the DC mains cable from the monitor.

**Maximum power consumption with maximum luminance.

Activate the computer and the monitor to gain access to the OSD.

Pin Assignments

HDMI connector

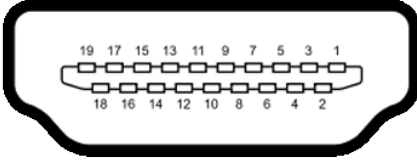

| Pin number | 19-pin side of the connected signal cable |
|------------|---|
| 1 | TMDS DATA 2+ |
| 2 | Shield GND |
| 3 | TMDS DATA 2- |
| 4 | TMDS DATA 1+ |
| 5 | Shield GND |
| 6 | TMDS DATA 1- |
| 7 | TMDS DATA 0+ |
| 8 | Shield GND |
| 9 | TMDS DATA 0- |
| 10 | TMDS CLOCK+ |
| 11 | Shield GND |
| 12 | TMDS CLOCK- |
| 13 | CEC |
| 14 | NC |
| 15 | DDC CLOCK (SCL) |
| 16 | DDC DATA (SDA) |
| 17 | GND |
| 18 | +5 V POWER |
| 19 | HOT PLUG DETECT |

mDP connector

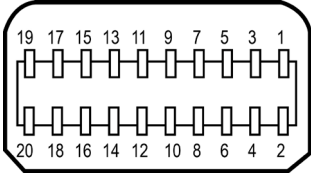

| Pin number | 20-pin side of the connected signal cable |
|------------|---|
| 1 | GND |
| 2 | Hot Plug Detect |
| 3 | ML3 (n) |
| 4 | CONFIG1 |
| 5 | ML3 (p) |
| 6 | CONFIG2 |
| 7 | GND |
| 8 | GND |
| 9 | ML2 (n) |
| 10 | ML0 (n) |
| 11 | ML2 (p) |
| 12 | ML0 (p) |
| 13 | GND |
| 14 | GND |
| 15 | ML1 (n) |
| 16 | AUX (p) |
| 17 | ML1 (p) |
| 18 | AUX (n) |
| 19 | Return |
| 20 | DP_PWR |

USB Type C Connector

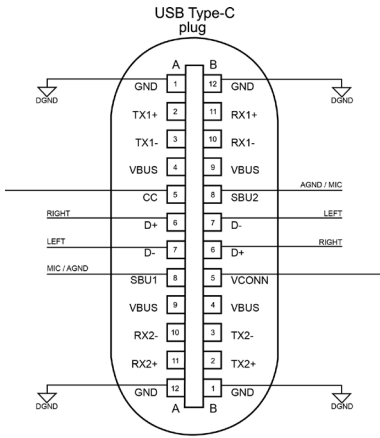

| Pin | Signal Assignment | Pin | Signal Assignment |
|------------|-------------------|------------|-------------------|
| A1 | GND | B12 | GND |
| A2 | TX1+ | B11 | RX1+ |
| A3 | TX1- | B10 | RX1- |
| A4 | VBUS | B9 | VBUS |
| A5 | CC | B8 | SBU2 |
| A6 | D + | B7 | D - |
| A7 | D - | B6 | D + |
| A8 | SBU1 | B5 | VCONN |
| A9 | VBUS | B4 | VBUS |
| A10 | RX2- | B3 | TX2- |
| A11 | RX2+ | B2 | TX2+ |
| A12 | GND | B1 | GND |

Plug-and-Play

You can install the monitor in any Plug-and-Play-compatible system. The monitor automatically provides the computer system with its extended display identification data (EDID) using display data channel (DDC) protocols so the computer can configure itself and optimize the monitor settings. Most monitor installations are automatic; you can select different settings if desired. For more information about changing the monitor settings, see [Operating the Monitor](#).

OLED Monitor Quality and Pixel Policy

During the OLED monitor manufacturing process, it is not uncommon for one or more pixels to become fixed in an unchanging state which are hard to see and do not affect the display quality or usability. For more information on OLED Monitor Pixel Policy, see Dell support site at: <http://www.dell.com/support/monitors>.

Setting Up the Monitor

Attaching the Stand



NOTE: The stand riser and stand base are detached when the monitor is shipped from the factory.



NOTE: The procedure below is applicable for the default stand. If you purchased any other stand, see the documentation shipped with the stand to set it up.



CAUTION: Place monitor on a flat, clean, and soft surface to avoid scratching the display panel.

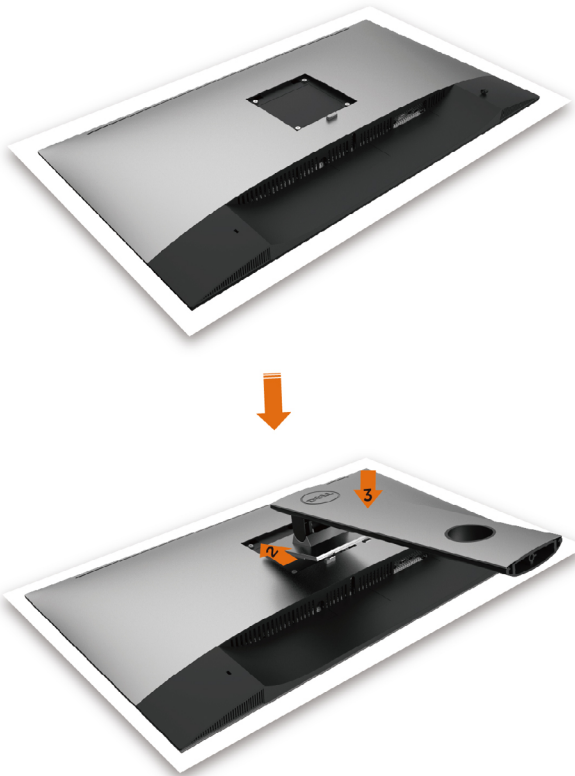

To attach the monitor stand:

- 1 Remove the monitor protective cover and place the monitor with its front facing downward on it.
- 2 Insert the two tabs on the upper part of the stand to the groove on the back of the monitor.
- 3 Press the stand down till it snaps into its place.

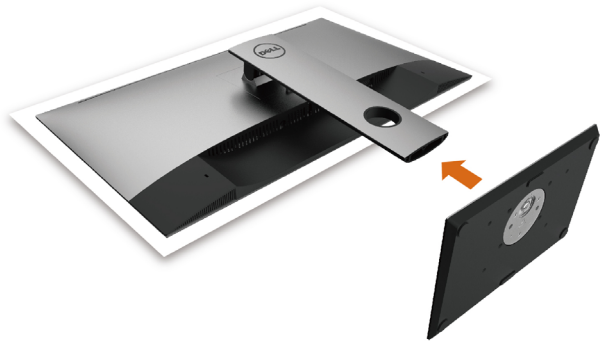

- Hold the stand base with the triangle mark ▲ facing upward.

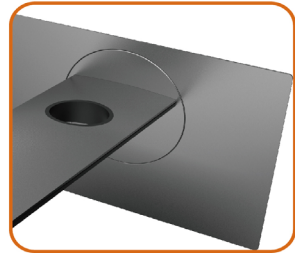
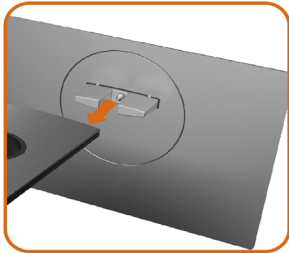

- Align the stand base protruding blocks to the matching slot on the stand.
- Insert the stand base blocks fully into the stand slot.



- Lift the screw handle and turn the screw clockwise.
- After fully tightening the screw, fold the screw handle flat within the recess.

Using the Tilt, Swivel and Vertical Extension

 **NOTE:** This is applicable for a monitor with a stand. If you purchased any other stand, refer to the respective stand setup guide for set up instructions.

Tilt, Swivel and Vertical Extension

With the stand attached to the monitor, you can tilt the monitor for the most comfortable viewing angle.

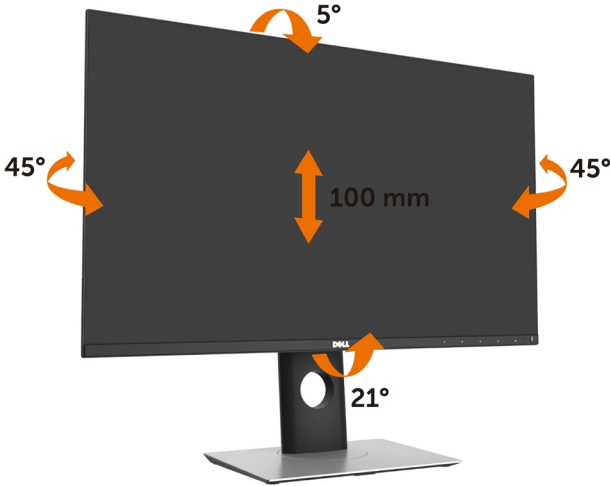

 **NOTE:** The stand is detached when the monitor is shipped from the factory.

Adjusting the Rotation Display Settings of Your System

After you have rotated your monitor, you need to complete the procedure below to adjust the Rotation Display Settings of your System.

 **NOTE:** If you are using the monitor with a non-Dell computer, you need to go the graphics driver website or your computer manufacturer website for information on rotating the 'contents' on your display.

To adjust the Rotation Display Settings:

- 1 Right-click on the desktop and click Properties.
- 2 Select the Settings tab and click Advanced.
- 3 If you have an ATI graphics card, select the Rotation tab and set the preferred rotation.
- 4 If you have an nVidia graphics card, click the nVidia tab, in the left-hand column select NVRotate, and then select the preferred rotation.
- 5 If you have an Intel® graphics card, select the Intel graphics tab, click Graphic Properties, select the Rotation tab, and then set the preferred rotation.

NOTE: If you do not see the rotation option or it is not working correctly, go to www.dell.com/support and download the latest driver for your graphics card.

Connecting Your Monitor

WARNING: Before you begin any of the procedures in this section, follow the [Safety Instructions](#).

To connect your monitor to the computer:

- 1 Turn off your computer.
- 2 Connect the HDMI/mDP to DP/mDP to mDP/USB Type C cable from your monitor to the computer.
- 3 Switch on your monitor.
- 4 Select the correct input source at Monitor OSD Menu and turn on your computer.

Connecting the HDMI cable

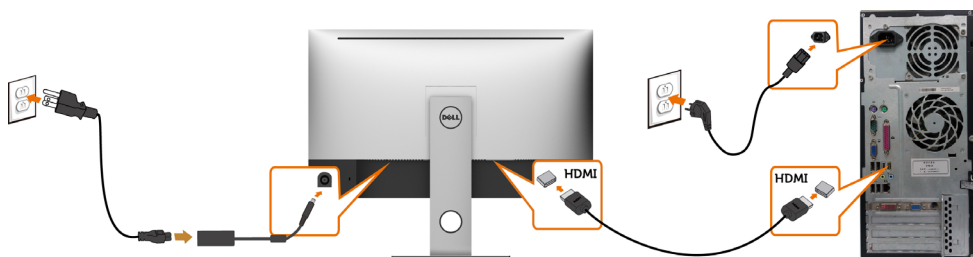

Connecting the mDP to DP cable

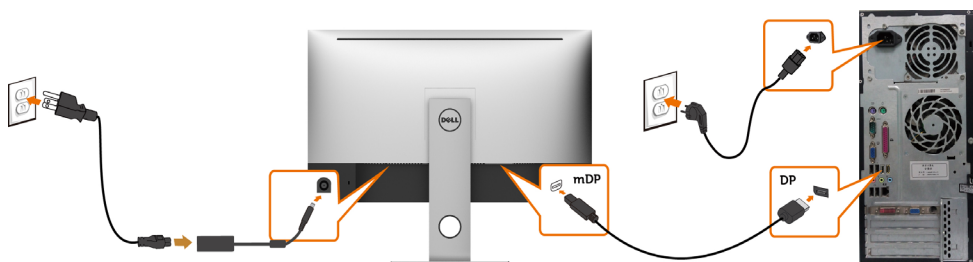

Connecting the mDP to mDP cable

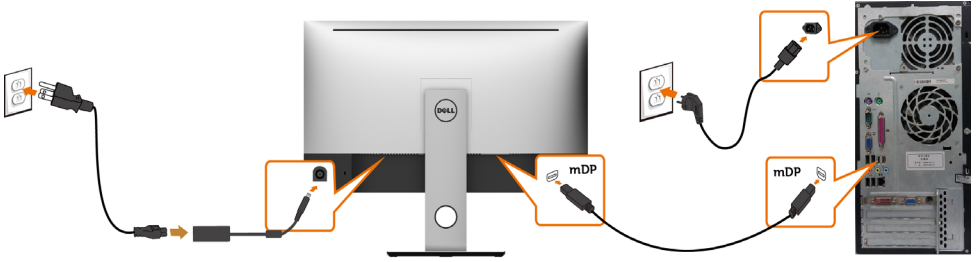

Connecting the USB Type C cable(C to C)

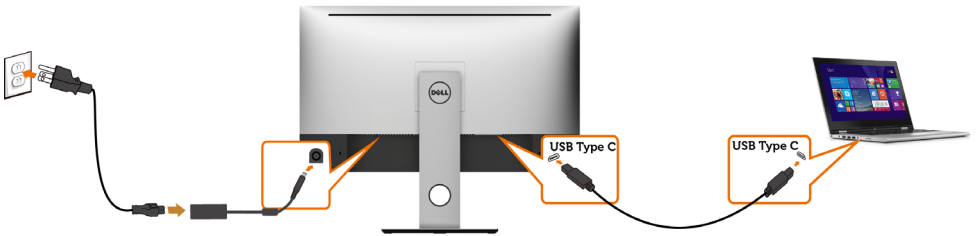

NOTE:

- 1 Support USB Type C Alternate mode with DP 1.2, DP1.1 is not supported.
- 2 Support USB PD (Power Delivery) profiles up to 100W.
- 3 If your Notebook required >100W to operate and the battery is drained, it may not power up or charge with UP3017Q USB PD.

Connecting the USB Type C cable(C to A)

 NOTE: Only needed when calibrating the Display with Dell Ultrasharp Color Calibration Software.

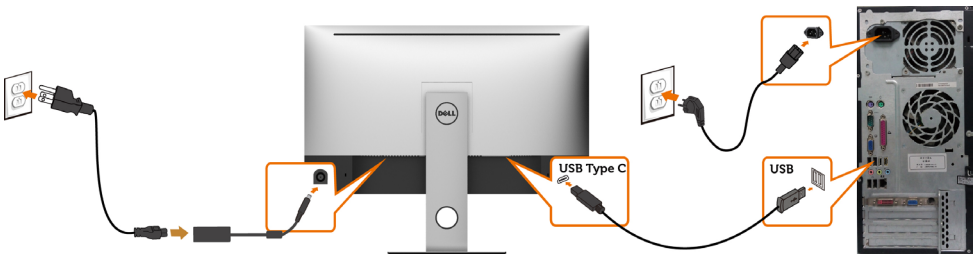

Organizing Your Cables

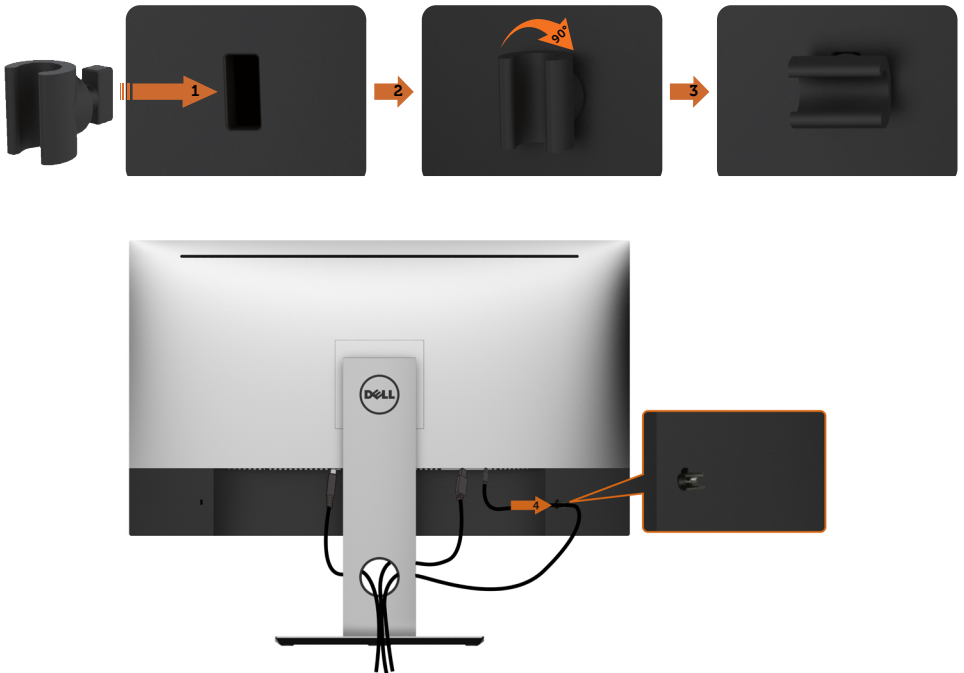

To attach the Cable holder:

- 1 Place Cable holder into back cover Security lock slot.
- 2 Rotate 90 degree of Cable holder.
- 3 The USB Type C cable through the cable clip to fix it as picture shown.

After attaching all necessary cables to your monitor and computer, (see [Connecting Your Monitor](#) for cable attachment) organize all cables as shown above.

Removing the Monitor Stand



CAUTION: To prevent scratches on the OLED screen while removing the stand, make sure that the monitor is placed on a soft, clean surface.



NOTE: The procedure below is applicable for the default stand. If you purchased any other stand, see the documentation shipped with the stand to set it up.

To remove the stand:

- 1 Place the monitor on a soft cloth or cushion.
- 2 Press and hold the stand-release button.
- 3 Lift the stand up and away from the monitor.



Wall Mounting (Optional)



 **NOTE:** Use M4 x 10 mm screws to connect the monitor to the wall-mounting kit.

Refer to the instructions that come with the VESA-compatible wall mounting kit.

- 1 Place the monitor on a soft cloth or cushion on a stable, flat table.
- 2 Remove the stand.
- 3 Use a Phillips crosshead screwdriver to remove the four screws securing the plastic cover.
- 4 Attach the mounting bracket from the wall mounting kit to the monitor.
- 5 Mount the monitor on the wall by following the instructions that comes with the wall mounting kit.

 **NOTE:** For use only with UL or CSA or GS-listed wall mount bracket with minimum weight/load bearing capacity of 6.43 Kg (14.17 lb).

OLED Screen Protection Mode

This UP3017Q internal firmware algorithm is able to analyze the image display on the screen dynamically. Assuming no user is present when there is no content changes for a prolong period of time, it will turn off the screen.

The Screen Protection Mode feature effectively extends the panel lifespan and reduces power consumption.

When the screen protection feature is activated, the left side OSD button LED will blink and the screen will be dimmed and turn off after 5 minutes and 15 sec respectively.

NOTE:

To exit screen protection mode, touch any of the OSD buttons or create some movements in the screen content, eg drag a window to another location, move the mouse cursor(left to right edge or top to bottom edge and back).

For a consistent user experience, the appearance of the Screen Protection mode is designed to behave similar to host PC/Notebook goes to sleep (making the Display going into Standby mode, the power button LED is blinking during Standby mode). To recover from Standby, wake the PC/Notebook by the mouse or keyboard. When video signal is restored, the display will exit Standby.

For the most effective screen protection and best experience, set the display to its native resolution of 3840x2160. Use vibrant color patterns or pictures as desktop, avoid using mono-color(eg grey) as desktop pattern. If you intent to leave your workstation, stop or pause any movie clips or animations.

For best panel (color) performance over time, please set Computer & Display Sleep from your Operating System to 5 minutes or less.

Operating the Monitor

Turning on the Monitor

Press the  button to turn on the monitor.







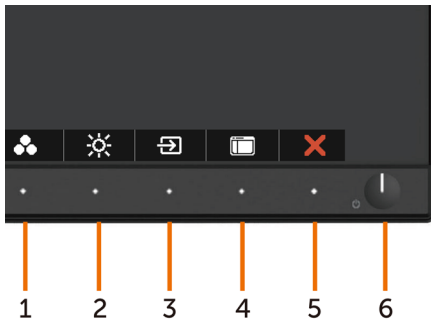

Using the Front Panel Controls

Use the control buttons on the front of the monitor to adjust the characteristics of the image being displayed. As you use these buttons to adjust the controls, an OSD shows the numeric values of the characteristics as they change.







The following table describes the front panel buttons:

| Front-Panel Button | Description |
|--|---|
| 1  Shortcut key: Preset Modes | Use this button to choose from a list of preset color modes. |
| 2  Shortcut key: Brightness | Use this button to directly access the Brightness menu. |
| 3  Shortcut key: Input Source | Use this button to choose from a list of Input Source. |
| 4  Menu | Use this menu button to launch the on-screen display (OSD) and select the OSD menu. See Accessing the Menu System . |
| 5  Exit | Use this button to go back to the main menu or exit the OSD main menu. |
| 6  Power (with power light indicator) | Use the Power button to turn the monitor On and Off. The white LED indicates the monitor is On and fully functional. A glowing white LED indicates DPMS Power Save Mode. |

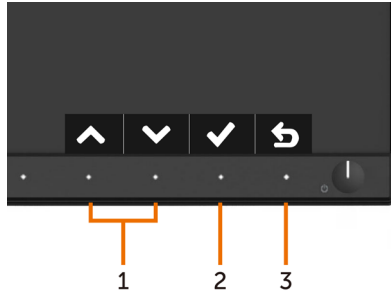
Front-Panel Button

Use the buttons on the front of the monitor to adjust the image settings.



| Front Panel Button | Description |
|--|---|
| 1   Up Down | Use the Up (increase) and Down (decrease) keys to adjust items in the OSD menu. |
| 2  OK | Use the OK button to confirm your selection. |
| 3  Back | Use the Back button to go back to the previous menu. |









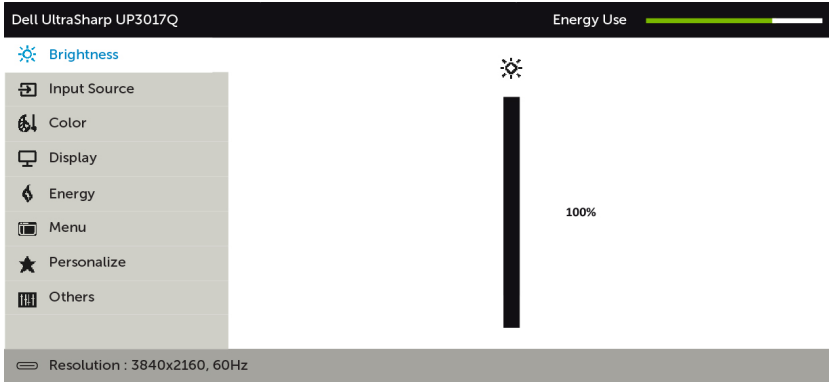

Using the On-Screen Display (OSD) Menu

Accessing the Menu System

 **NOTE:** Any changes you make using the OSD menu are automatically saved if you move to another OSD menu, exit the OSD menu, or wait for the OSD menu to disappear.

- 1 Press the  button to launch the OSD menu and display the main menu.



- 2 Press the  and  buttons to move between options. As you move from one icon to another, the option name is highlighted.
- 3 Press the  or  button once to activate the highlighted option.
- 4 Press the  and  buttons to select the desired parameter.
- 5 Press  to enter the slide bar and then use the  or  button, according to the indicators on the menu, to make your changes.
- 6 Select the  to return to previous menu or  to accept and return to previous menu.

Icon

Menu and Submenus

Description



Brightness

Use this menu to activate **Brightness** adjustment.

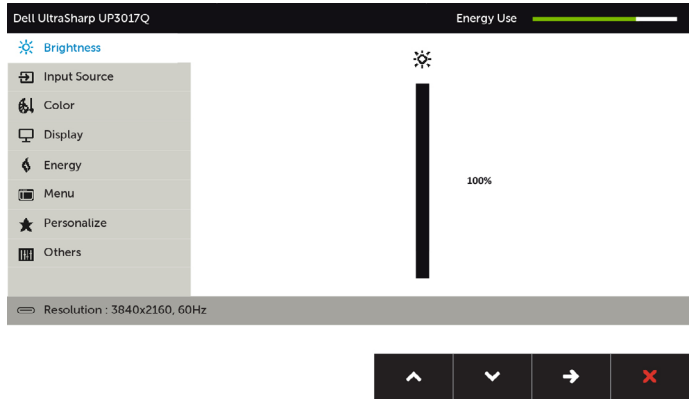

Brightness

Brightness adjusts the luminance of the backlight (minimum 0; maximum 100).

Press the  button to increase brightness.





Press the  button to decrease brightness.

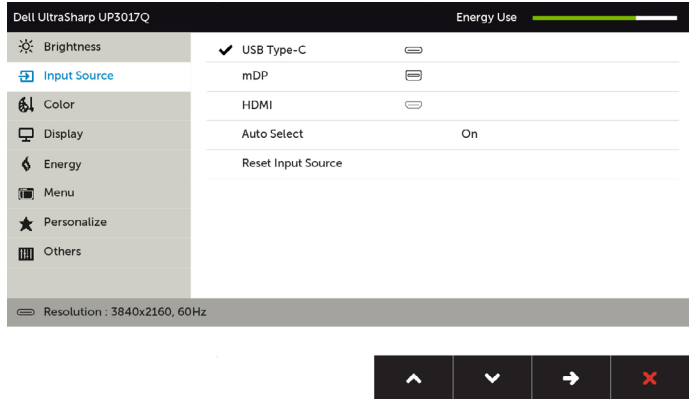

Input Source

Use the **Input Source** menu to select between different video inputs that are be connected to your monitor.



| Icon | Menu and Submenus | Description |
|--|---------------------------|--|
| | USB Type-C | Select USB Type-C input when you are using the USB Type-C connector. Use  to select the USB Type-C input source. |
| | mDP | Select mDP input when you are using the mDP (mini DisplayPort) connector. Use  to select the mDP input source. |
| | HDMI | Select the HDMI input when you are using the HDMI connector. Use  to select the HDMI input source. |
| | Auto Select | Use  to select Auto Select , the monitor scans for available input sources. |
| | Reset Input Source | Resets your monitor's Input Source settings to the factory defaults. |
|  | Color | Use the Color menu to adjust the color setting mode. |

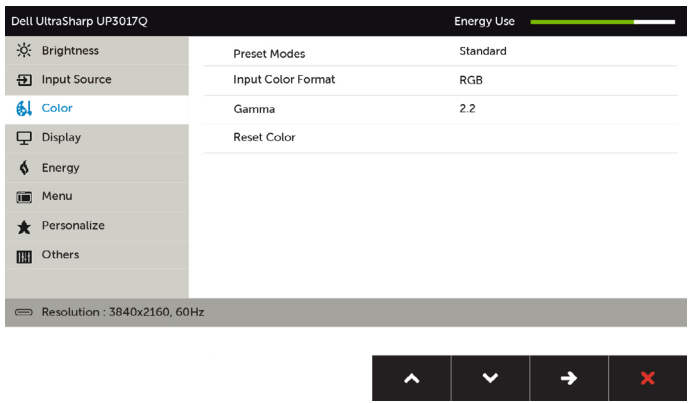

| Icon | Menu and Submenus | Description |
|------|-------------------|-------------|
|------|-------------------|-------------|

Preset Modes When you select **Preset Modes**, you can choose **Standard**, **Multimedia**, **Movie**, **Paper**, **Color Temp.**, **Color Space** or **Custom Color** from the list.

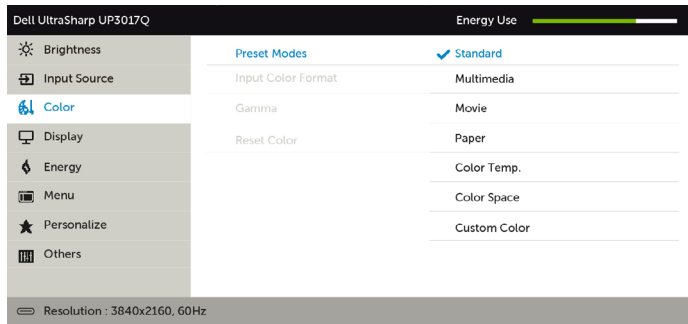

- **Standard:** Default color settings. This is the default preset mode.
- **Multimedia:** Ideal for multimedia applications.
- **Movie:** Ideal for movies.
- **Paper:** Loads brightness and sharpness settings ideal for viewing text. Blend the text background to simulate paper media without affecting color images.
- **Color Temp.:** The screen appears warmer with a red/yellow tint with slider set at 5,000K or cooler with blue tint with slider set at 10,000K.
- **Color Space:** Allows users to select the color space: **Adobe RGB**, **sRGB**, **REC709**, **DCI-P3**, **CAL1**, **CAL2**.



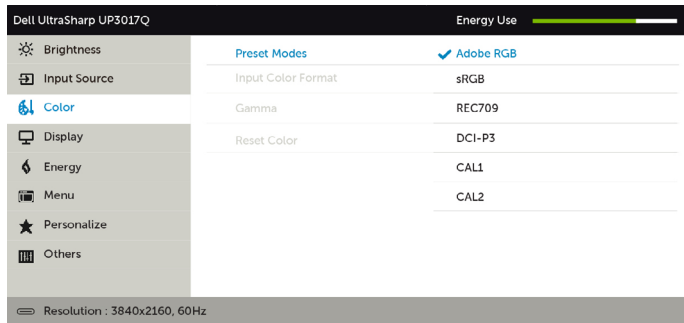

| Icon | Menu and Submenus | Description |
|------|-------------------|-------------|
|------|-------------------|-------------|



- **Adobe RGB:** This mode matches 100% Adobe RGB standard.
- **sRGB:** This mode matches 100% sRGB standard.
- **REC709:** This mode matches 100% REC709 standard.
- **DCI-P3:** This mode reproduces 97.5% of DCI-P3 digital cinema color standard.

NOTE: Accuracy of **sRGB**, **Adobe RGB**, **REC709**, **DCI-P3**, **CAL1** and **CAL2** are optimized for RGB input color format.

| Icon | Menu and Submenus | Description |
|------|-------------------|-------------|
|------|-------------------|-------------|

- **Custom Color:** Allows you to manually adjust the color settings. Press the  and  buttons to adjust the Red, Green, and Blue values and create your own preset color mode. Use the  and  buttons to select the **Gain, Offset, Hue, Saturation.**

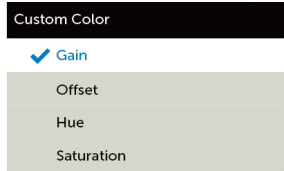

- **Gain:** Select it to adjust input RGB signal gain level (default value is 100).
- **Offset:** Select it to adjust RGB black-level offset value (default value is 50) to control your monitor base color.
- **Hue:** Select it to adjust RGBCMY hue value individually (default value is 50).
- **Saturation:** Select it to adjust RGBCMY saturation value individually (default value is 50).

Input Color Format



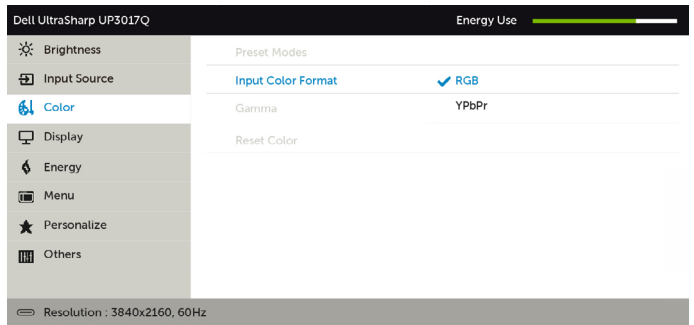

Allows you to set the video input mode to:

- **RGB:** Select this option if your monitor is connected to a computer (or DVD player) using the HDMI or mDP-DP cable.
- **YPbPr:** Select this option if your DVD player supports only YPbPr output.

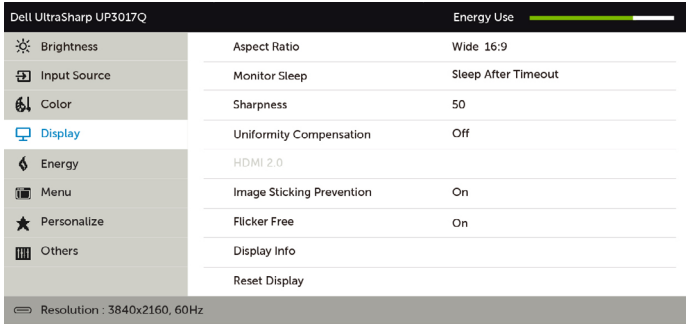

Gamma

Allows you to set the display Gamma according to your system.

| Icon | Menu and Submenus | Description |
|--|--|---|
| | Reset Color | Resets your monitor's color settings to the factory defaults. |
|  | Display | Use the Display menu to adjust image. |
| |  | |
| |  | |
| | Aspect Ratio | Adjust the image ratio to Wide 16:9 , Auto Resize , 4:3 , or 1:1 . |
| | Monitor Sleep | Sleep After Timeout: Monitor goes into sleep(power save mode) after timeout. Never: Monitor never go into sleep(power save mode). When signal from PC is received, monitor will recover faster. |
| | Sharpness | Makes the image look sharper or softer. Use  or  to adjust the sharpness from '0' to '100'. |
| | Uniformity Compensation | Select screen brightness and color uniformity compensation settings. Calibrated is factory calibrated setting by default. Uniformity Compensation adjusts different areas of the screen with respect to the center to achieve uniform brightness and color over the entire screen. |
| | HDMI 2.0 | For switch HDMI1.4/HDMI2.0. NOTE: Ensure that your Graphics Card can support these features before selecting HDMI2.0. Wrong settings may result in blank screen. |
| | Image Sticking Prevention | Select this option to ON/OFF the feature. You notice pixel very slowly shifting on your monitor when the feature is ON. |
| | Flicker Free | Flicker Free On eliminates flickering by doubling the screen frame rate. |
| | Display Info | Displays the monitor's current settings. |
| | Reset Display | Restores the display settings to factory defaults. |

| Icon | Menu and Submenus | Description |
|------|-------------------|-------------|
|------|-------------------|-------------|



Energy

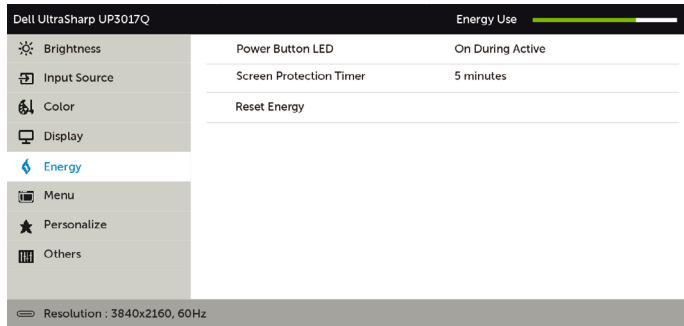

| | |
|--------------------------------|---|
| Power Button LED | Allows you to set the state of the power light to save energy. |
| Screen Protection Timer | When the screen protection feature is activated, the left side OSD button LED will blink and the screen will be dimmed and turn off after 5/10 minutes. |
| Reset Energy | Select this option to restore default Energy settings. |

| Icon | Menu and Submenus | Description |
|------|-------------------|-------------|
|------|-------------------|-------------|



Menu

Select this option to adjust the settings of the OSD, such as, the languages of the OSD, the amount of time the menu remains on screen, and so on.

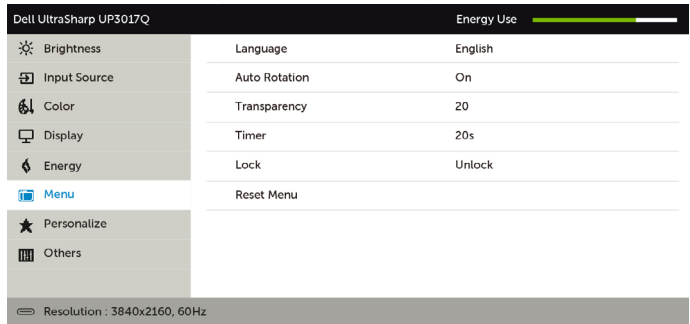

| | |
|----------------------|---|
| Language | Set the OSD display to one of eight languages. (English, Spanish, French, German, Brazilian Portuguese, Russian, Simplified Chinese, or Japanese). |
| Auto Rotation | Rotates the OSD by 90 degrees counter-clockwise. You can adjust the menu according to your display rotation. |
| Transparency | Select this option to change the menu transparency by using and (min. 0 / max. 100). |
| Timer | OSD Hold Time: Sets the length of time the OSD remains active after you press a button. Use the and buttons to adjust the slider in 1-second increments, from 5 to 60 seconds. |
| Lock | Controls user access to adjustments. When Lock is selected, no user adjustments are allowed. All buttons are locked. NOTE: Lock function - Either soft lock (through OSD menu) or hard lock (Press and hold the exit button 6 sec) Unlock function - Only hard unlock (Press and hold the exit button 6 sec) |
| Reset Menu | Restore the menu settings to factory defaults. |

| Icon | Menu and Submenus | Description |
|------|-------------------|-------------|
|------|-------------------|-------------|



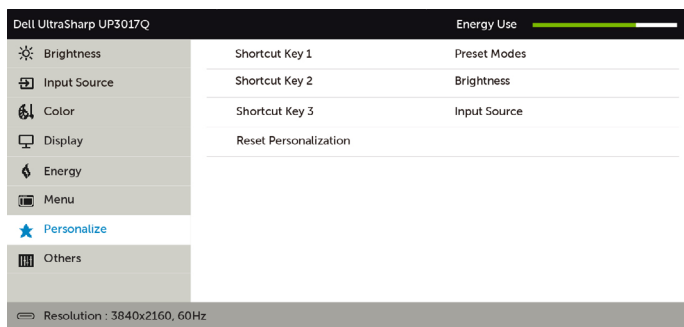

Personalize

Select from **Preset Modes, Brightness, Input Source, Aspect Ratio** set as shortcut key.

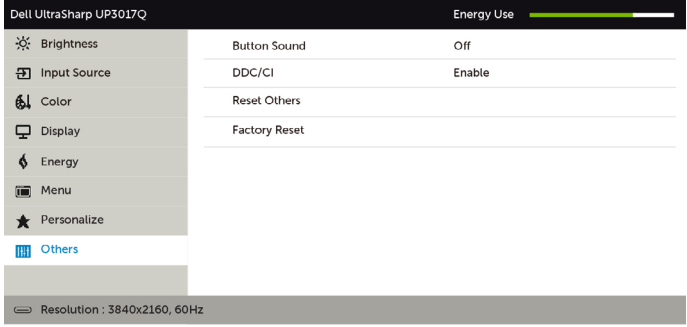

Reset Personalization

Restores shortcut keys to factory defaults.

| Icon | Menu and Submenus | Description |
|--|-------------------|--|
|  | Other |  |
| | |  |

Select this option to adjust the OSD settings.

Button Sound

The monitor beeps every time a new option is selected in the menu. This feature On or Off the sound.

DDC/CI

DDC/CI (Display Data Channel/Command Interface) allows you to adjust the monitor settings using software on your computer.

Select **Disable** to turn off this feature.

Enable this feature for best user experience and optimum performance of your monitor.

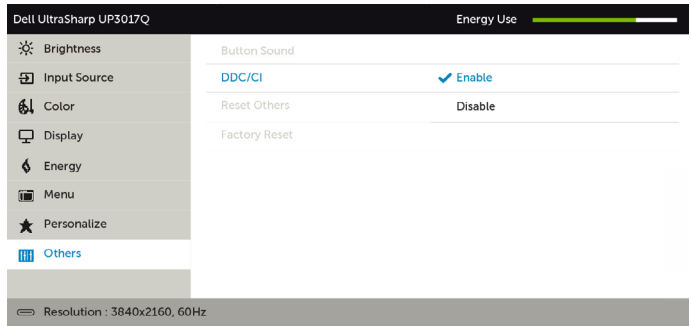

Reset Others Restores other settings, such as **DDC/CI**, to factory defaults.

Factory Reset Restores all OSD settings to the factory defaults.

OSD Warning Messages

When the monitor does not support a particular resolution mode, you can see the following message:

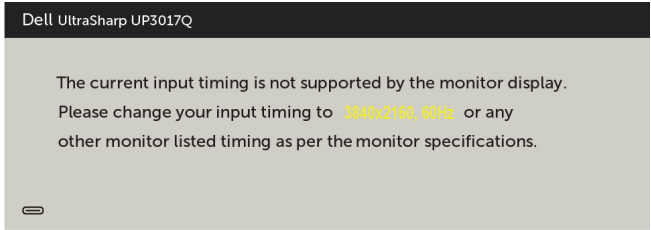

This means that the monitor cannot synchronize with the signal that it is receiving from the computer. See [Monitor Specifications](#) for the Horizontal and Vertical frequency ranges addressable by this monitor. Recommended mode is 3840 x 2160.

You can see the following message before the DDC/CI function is disabled:

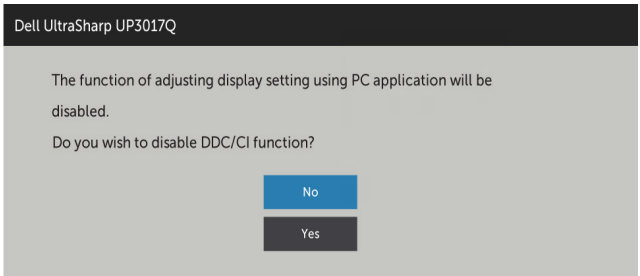

When the monitor enters the **Power Save** mode, the following message appears:

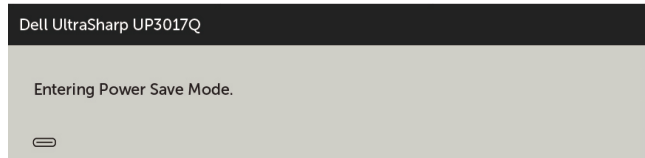

Activate the computer and wake up the monitor to gain access to the [OSD](#).

If you press any button other than the power button, the following messages will appear depending on the selected input:

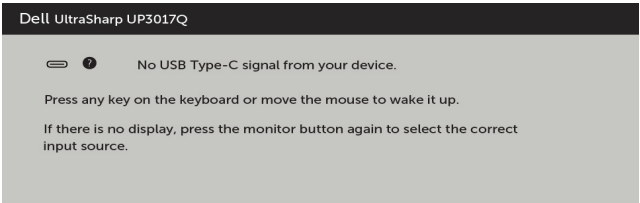

If either HDMI, mDP, USB Type-C input is selected and the corresponding cable is not connected, a floating dialog box as shown below appears.

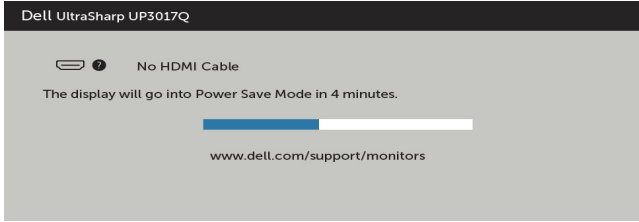

or

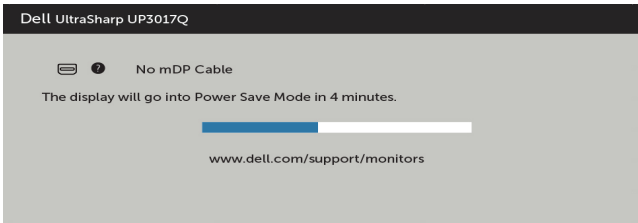

or

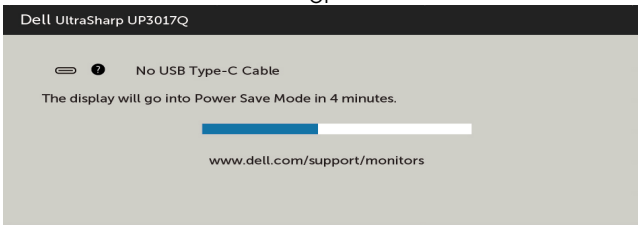

See [Troubleshooting](#) for more information.

Troubleshooting

⚠ WARNING: Before you begin any of the procedures in this section, follow the [Safety Instructions](#).

Self-Test

Your monitor provides a self-test feature that allows you to check whether your monitor is functioning properly. If your monitor and computer are properly connected but the monitor screen remains dark, run the monitor self-test by performing the following steps:

- 1 Turn off both your computer and the monitor.
- 2 Unplug the video cable from the back of the computer. To ensure proper Self-Test operation, remove all digital and the analog cables from the back of computer.
- 3 Turn on the monitor.

The floating dialog box should appear on-screen (against a black background), if the monitor cannot sense a video signal and is working correctly. While in self-test mode, the power LED remains white. Also, depending upon the selected input, one of the dialogs shown below will continuously scroll through the screen.

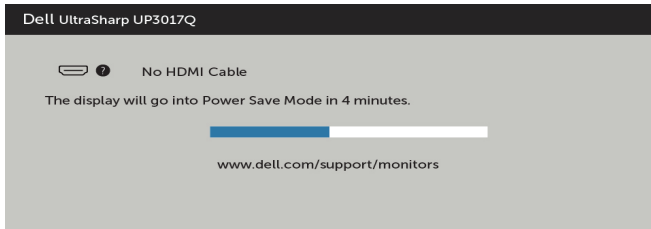

or

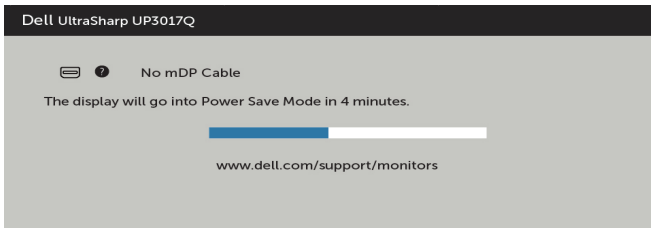

or

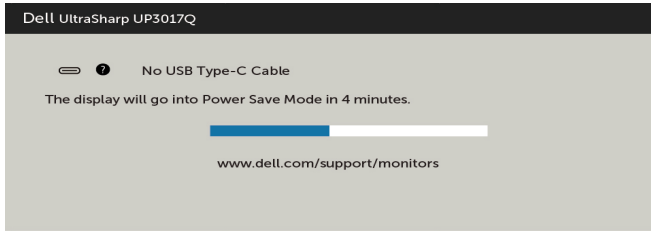

- 4 This box also appears during normal system operation, if the video cable becomes disconnected or damaged.
- 5 Turn off your monitor and reconnect the video cable; then turn on both your computer and the monitor.

If your monitor screen remains blank after you use the previous procedure, check your video controller and computer, because your monitor is functioning properly.

Built-in Diagnostics

Your monitor has a built-in diagnostic tool that helps you determine if the screen abnormality you are experiencing is an inherent problem with your monitor, or with your computer and video card.

 **NOTE:** You can run the built-in diagnostics only when the video cable is unplugged and the monitor is in self-test mode.

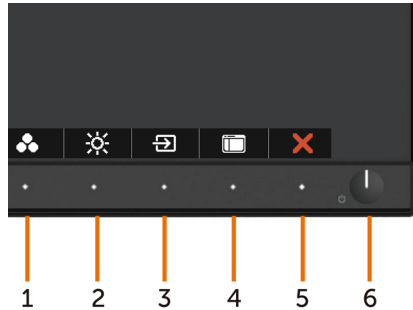

To run the built-in diagnostics:

- 1 Make sure that the screen is clean (no dust particles on the surface of the screen).
- 2 Unplug the video cable(s) from the back of the computer or monitor. The monitor then goes into the self-test mode.
- 3 Press and hold **Button 1** for 5 seconds. A gray screen appears.
- 4 Carefully inspect the screen for abnormalities.
- 5 Press **Button 1** on the front panel again. The color of the screen changes to red.
- 6 Inspect the display for any abnormalities.
- 7 Repeat steps 5 and 6 to inspect the display in green, blue, black, white, and text screens.

The test is complete when the text screen appears. To exit, press **Button 1** again. If you do not detect any screen abnormalities upon using the built-in diagnostic tool, the monitor is functioning properly. Check the video card and computer.

Common Problems

The following table contains general information about common monitor problems you might encounter and the possible solutions:

| Common Symptoms | What You Experience | Possible Solutions |
|------------------------|----------------------------------|--|
| No Video/Power LED off | No picture | <ul style="list-style-type: none">• Ensure that the video cable connecting the monitor and the computer is properly connected and secure.• Verify that the power outlet is functioning properly using any other electrical equipment.• Ensure that the power button is depressed fully.• Ensure that the correct input source is selected in the Input Source menu. |
| No Video/Power LED on | No picture or no brightness | <ul style="list-style-type: none">• Increase brightness controls via OSD.• Perform monitor self-test feature check.• Check for bent or broken pins in the video cable connector.• Run the built-in diagnostics.• Ensure that the correct input source is selected in the Input Source menu. |
| Missing Pixels | screen has spots | <ul style="list-style-type: none">• Cycle power on-off.• Pixel that is permanently off is a natural defect that can occur in current display technology.• For more information on Dell Monitor Quality and Pixel Policy, see Dell Support site at: http://www.dell.com/support/monitors. |
| Stuck-on Pixels | screen has bright spots | <ul style="list-style-type: none">• Cycle power On-Off.• Pixel that is permanently off is a natural defect that can occur in current display technology.• For more information on Dell Monitor Quality and Pixel Policy, see Dell Support site at: http://www.dell.com/support/monitors. |
| Brightness Problems | Picture too dim or too bright | <ul style="list-style-type: none">• Reset the monitor to factory settings.• Adjust brightness control via OSD. |
| Safety Related Issues | Visible signs of smoke or sparks | <ul style="list-style-type: none">• Do not perform any troubleshooting steps.• Contact Dell immediately. |
| Intermittent Problems | Monitor malfunctions on & off | <ul style="list-style-type: none">• Ensure that the video cable connecting the monitor to the computer is connected properly and is secure.• Reset the monitor to factory settings.• Perform monitor self-test feature check to determine if the intermittent problem occurs in self-test mode. |

| Common Symptoms | What You Experience | Possible Solutions |
|---|--|--|
| Missing Color | Picture missing color | <ul style="list-style-type: none"> • Perform monitor self-test. • Ensure that the video cable connecting the monitor to the computer is connected properly and is secure. • Check for bent or broken pins in the video cable connector. |
| Wrong Color | Picture color not good | <ul style="list-style-type: none"> • Change the settings of the Preset Modes in the Color menu OSD depending on the application. • Adjust R/G/B value under Custom. Color in Color menu OSD. • Change the Input Color Format to PC RGB or YPbPr in the Color menu OSD. • Run the built-in diagnostics. |
| Image retention from a static image left on the monitor for a long period of time | Faint shadow from the static image displayed appears on the screen | <ul style="list-style-type: none"> • Use the Power Management feature to turn off the monitor at all times when not in use (for more information, see Power Management Modes). • Alternatively, use a dynamically changing screen saver. |

Product Specific Problems

| Specific Symptoms | What You Experience | Possible Solutions |
|---|--|---|
| Screen image is too small | Image is centered on screen, but does not fill entire viewing area | <ul style="list-style-type: none"> • Check the Aspect Ratio setting in the Display menu OSD. • Reset the monitor to factory settings. |
| Cannot adjust the monitor with the buttons on the front panel | OSD does not appear on the screen | <ul style="list-style-type: none"> • Turn off the monitor, unplug the monitor power cable, plug it back, and then turn on the monitor. • Check whether the OSD menu is locked. If yes, press and hold the button beside the power button for 6 seconds to unlock (for more information, see Lock). |
| No Input Signal when user controls are pressed | No picture, the LED light is white | <ul style="list-style-type: none"> • Check the signal source. Ensure the computer is not in the power saving mode by moving the mouse or pressing any key on the keyboard. • Check whether the signal cable is plugged in properly. Re-plug the signal cable if necessary. • Reset the computer or video player. |
| The picture does not fill the entire screen | The picture cannot fill the height or width of the screen | <ul style="list-style-type: none"> • Due to different video formats (aspect ratio) of DVDs, the monitor may display in full screen. • Run the built-in diagnostics. |

| Specific Symptoms | What You Experience | Possible Solutions |
|---|----------------------------|--|
| No image when using DP connection to the PC | Black screen | <ul style="list-style-type: none">• Verify which DP standard (DP 1.1a or DP 1.2) is your Graphics Card certified to. Download and install the latest graphics card driver.• Some DP 1.1a graphics card cannot support DP 1.2 monitors. Go to OSD menu, under Input Source selection, press and hold DP select  key for 8 sec to change the monitor setting from DP 1.2 to DP 1.1a. |

Appendix

Safety Instructions

For displays with glossy bezels the user should consider the placement of the display as the bezel may cause disturbing reflections from surrounding light and bright surfaces.

 **WARNING: Use of controls, adjustments, or procedures other than those specified in this documentation may result in exposure to shock, electrical hazards, and/or mechanical hazards.**

For information on safety instructions, see the Safety, Environmental, and Regulatory Information (SERI).

FCC Notices (U.S. only) and Other Regulatory Information

For FCC notices and other regulatory information, see the regulatory compliance website located at www.dell.com/regulatory_compliance.

Contacting Dell

 **NOTE:** If you do not have an active Internet connection, you can find contact information on your purchase invoice, packing slip, bill, or Dell product catalog.

Dell provides several online and telephone-based support and service options. Availability varies by country and product, and some services may not be available in your area.

To get online Monitor support content:

See www.dell.com/support/monitors.

To contact Dell for sales, technical support, or customer service issues:

- 1 Go to www.dell.com/support.
- 2 Verify your country or region in the Choose A Country/Region drop-down menu at the top-left corner of the page.
- 3 Click **Contact Us** next to the country dropdown.
- 4 Select the appropriate service or support link based on your need.
- 5 Choose the method of contacting Dell that is convenient for you.

Setting Up Your Monitor

Setting Display Resolution to 3840 x 2160 (maximum)

For best performance, set the display resolution to 3840 x 2160 pixels by performing the following steps:

In Windows Vista, Windows 7, Windows 8 or Windows 8.1:

- 1 For Windows 8 or Windows 8.1 only, select the Desktop tile to switch to classic desktop.
- 2 Right-click on the desktop and click **Screen Resolution**.
- 3 Click the Dropdown list of the Screen Resolution and select 3840 x 2160.
- 4 Click **OK**.

In Windows 10:

- 1 Right-click on the desktop and click **Display Settings**.
- 2 Click **Advanced display settings**.
- 3 Click the dropdown list of **Resolution** and select 3840 x 2160.
- 4 Click **Apply**.

If you do not see the recommended resolution as an option, you may need to update your graphics driver. Please choose the scenario below that best describes the computer system you are using, and follow the given steps.

Dell computer

- 1 Go to www.dell.com/support, enter your service tag, and download the latest driver for your graphics card.
- 2 After installing the drivers for your graphics adapter, attempt to set the resolution to 3840 x 2160 again.

 **NOTE:** If you are unable to set the resolution to 3840 x 2160, please contact Dell to inquire about a graphics adapter that supports these resolutions.

Non-Dell computer

In Windows Vista, Windows 7, Windows 8 or Windows 8.1:

- 1 For Windows 8 or Windows 8.1 only, select the Desktop tile to switch to classic desktop.
- 2 Right-click on the desktop and click **Personalization**.
- 3 Click **Change Display Settings**.
- 4 Click **Advanced Settings**.
- 5 Identify your graphics controller supplier from the description at the top of the window (e.g. NVIDIA, ATI, Intel etc.).
- 6 Refer to the graphic card provider website for updated driver (for example, <http://www.ATI.com> or <http://www.NVIDIA.com>).
- 7 After installing the drivers for your graphics adapter, attempt to set the resolution to **3840 x 2160** again.

In Windows 10:

- 1 Right-click on the desktop and click **Display Settings**.
- 2 Click **Advanced display settings**.
- 3 Click **Display adapter properties**.
- 4 Identify your graphics controller supplier from the description at the top of the window (e.g. NVIDIA, ATI, Intel etc.).
- 5 Refer to the graphic card provider website for updated driver (for example, <http://www.ATI.com> or <http://www.NVIDIA.com>).
- 6 After installing the drivers for your graphics adapter, attempt to set the resolution to 3840 x 2160 again.



NOTE: If you are unable to set the recommended resolution, please contact the manufacturer of your computer or consider purchasing a graphics adapter that supports the video resolution.

Maintenance Guidelines

Cleaning Your Monitor



WARNING: Before cleaning the monitor, unplug the monitor power cable from the electrical outlet.



CAUTION: Read and follow the [Safety Instructions](#) before cleaning the monitor.

For best practices, follow these instructions in the list below while unpacking, cleaning, or handling your monitor:

- To clean your anti-static screen, lightly dampen a soft, clean cloth with water. If possible, use a special screen-cleaning tissue or solution suitable for the anti-static coating. Do not use benzene, thinner, ammonia, abrasive cleaners, or compressed air.
- Use a lightly-dampened, soft cloth to clean the monitor. Avoid using detergent of any kind as some detergents leave a milky film on the monitor.
- If you notice white powder when you unpack your monitor, wipe it off with a cloth.
- Handle your monitor with care as a darker-colored monitor may get scratched and show white scuff marks more than a lighter-colored monitor.
- To help maintain the best image quality on your monitor, use a dynamically changing screen saver and turn off your monitor when not in use.